



NTSC U/C

PlayStation™



SLUS-00602
94012



NEWMAN HANNAH™ RACING

a winning indy car tradition



WARNING: READ BEFORE USING YOUR PLAYSTATION™ GAME CONSOLE.

A very small percentage of individuals may experience epileptic seizures when exposed to certain light patterns or flashing lights. Exposure to certain patterns or backgrounds on a television screen or while playing video games, including games played on the PlayStation game console, may induce an epileptic seizure in these individuals. Certain conditions may induce previously undetected epileptic symptoms even in persons who have no history of prior seizures or epilepsy. If you, or anyone in your family, has an epileptic condition, consult your physician prior to playing. If you experience any of the following symptoms while playing a video game – dizziness, altered vision, eye or muscle twitches, loss of awareness, disorientation, any involuntary movement, or convulsions – IMMEDIATELY discontinue use and consult your physician before resuming play.

WARNING TO OWNERS OF PROJECTION TELEVISIONS:

Do not connect your PlayStation game console to a projection TV without first consulting the user manual for your projection TV, unless it is of the LCD type. Otherwise, it may permanently damage your TV screen.

HANDLING YOUR PLAYSTATION™ DISC:

- This compact disc is intended for use only with the PlayStation™ game console.
- Do not bend it, crush it or submerge it in liquids.
- Do not leave it in direct sunlight or near a radiator or other source of heat.
- Be sure to take an occasional rest break during extended play.
- Keep this compact disc clean. Always hold the disc by the edges and keep it in its protective case when not in use. Clean the disc with a lint-free, soft, dry cloth, wiping in straight lines from center to outer edge. Never use solvents or abrasive cleaners.

CONTENTS

Set-Up	2
Introduction	4
Starting Up the Game	4
Default Controls	5
Manual Shifting Controls	5
The Option Wheel	6
The Three Racing Types	10
Practice	10
Challenge Racing	15
Pause Menu	16
Championship Racing	16
Quit/Continue/Save Screen	18
Loading	18
Pit Stops	18
Two Player/Split Screen	19

SET-UP

Console

Top View

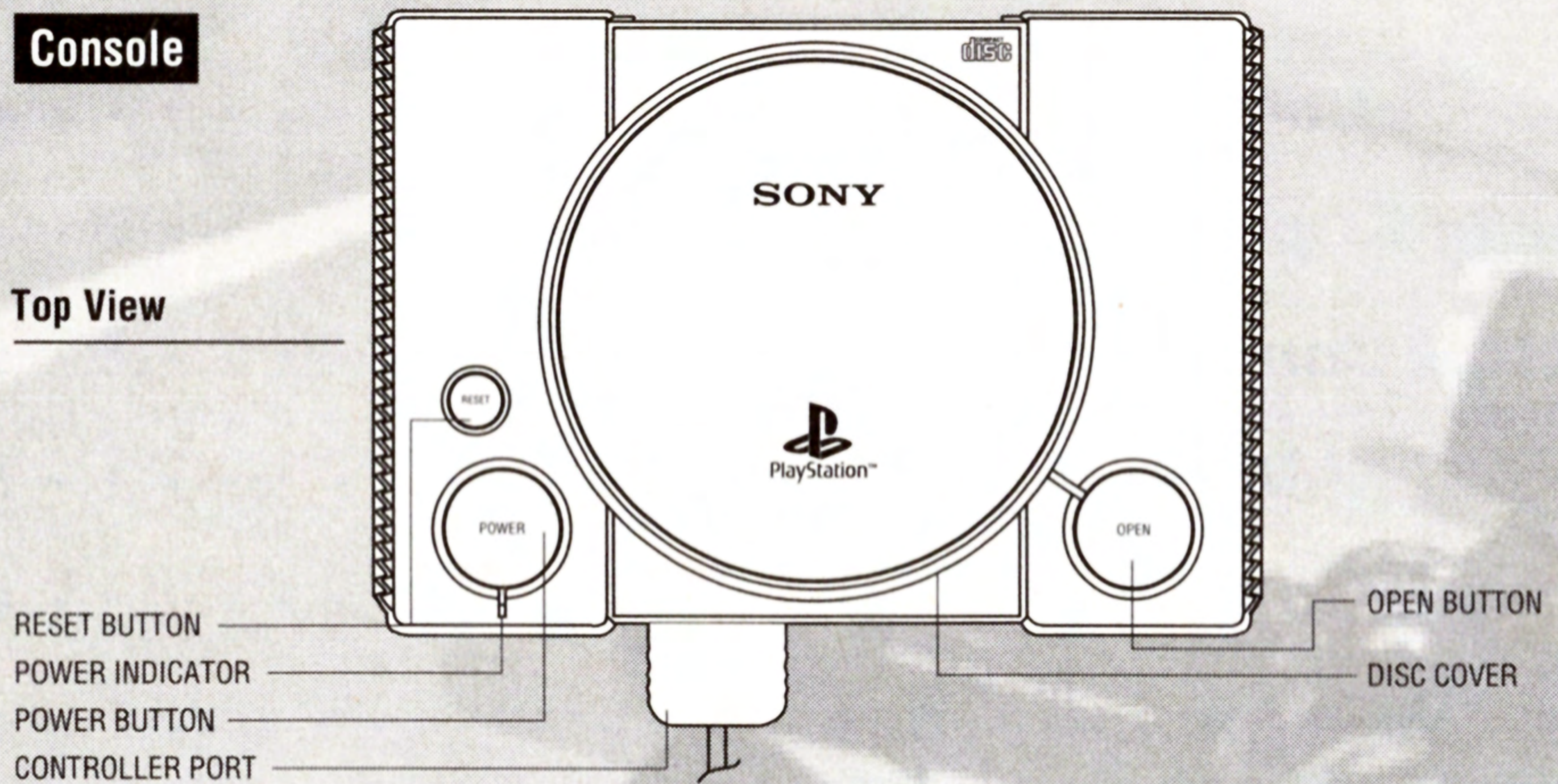

Front View

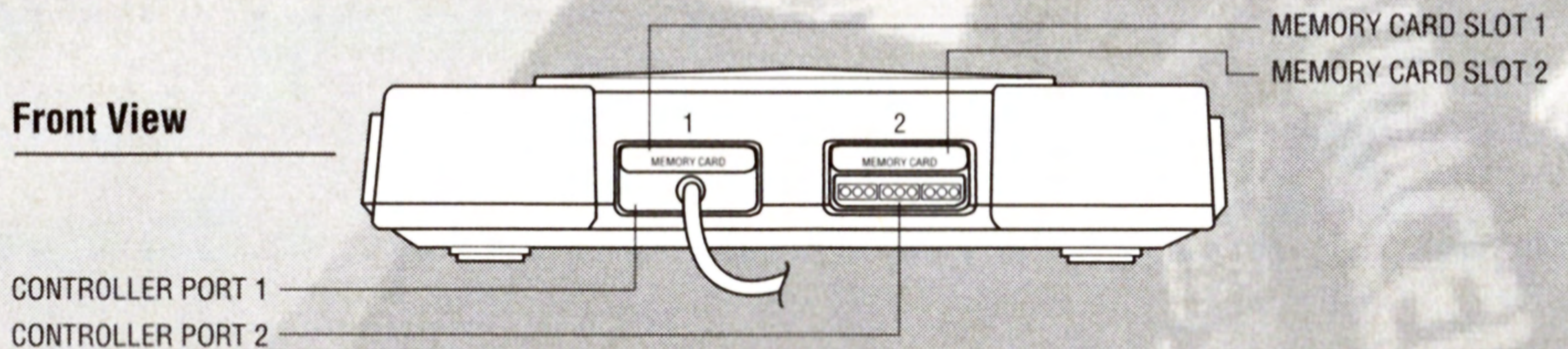

Set up your PlayStation™ game console according to the instructions in its Instruction Manual. Make sure the power is off before inserting or removing a compact disc. Insert the Newman/Haas Racing disc and close the disc cover. Follow on-screen instructions to start the game.

IN-GAME CONTROLS

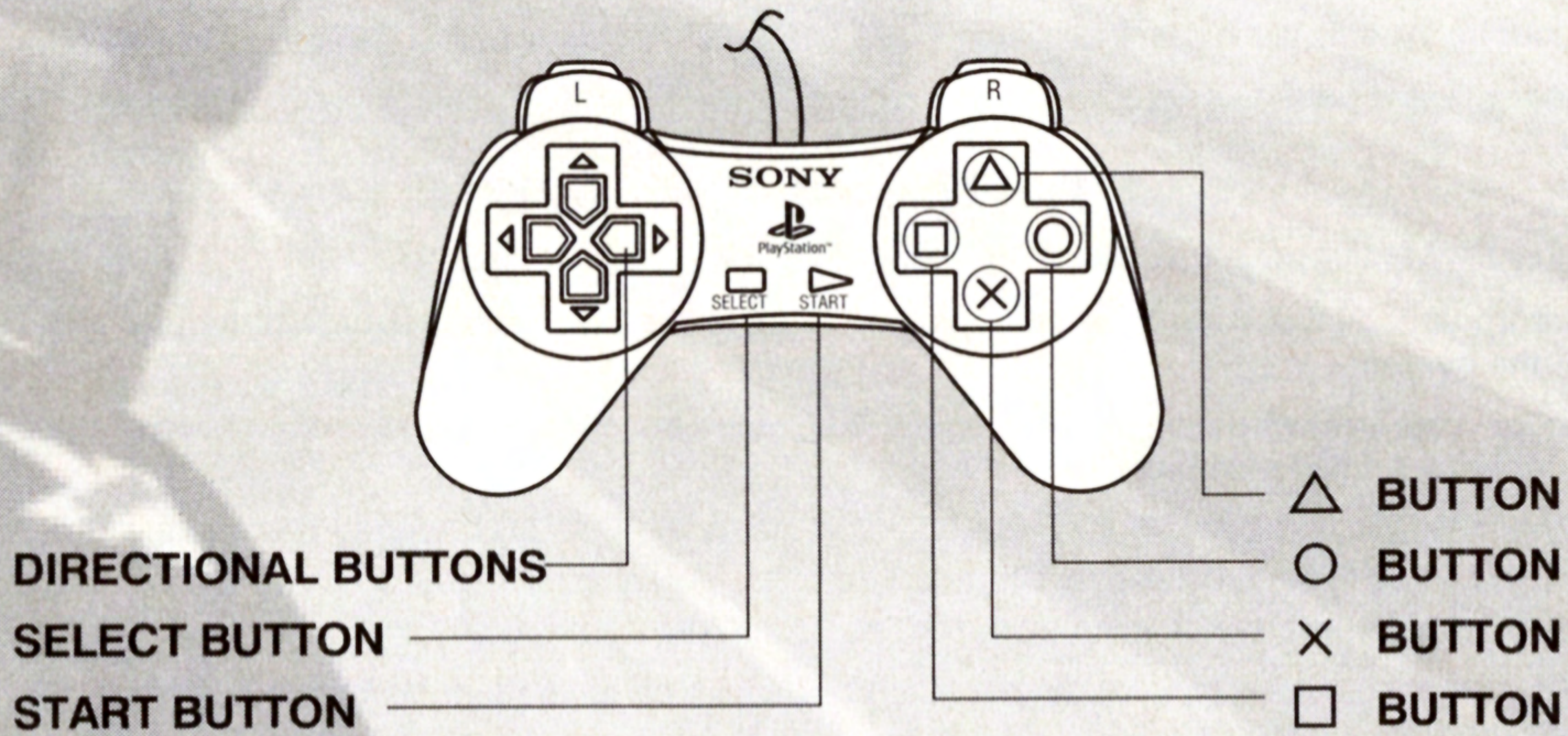
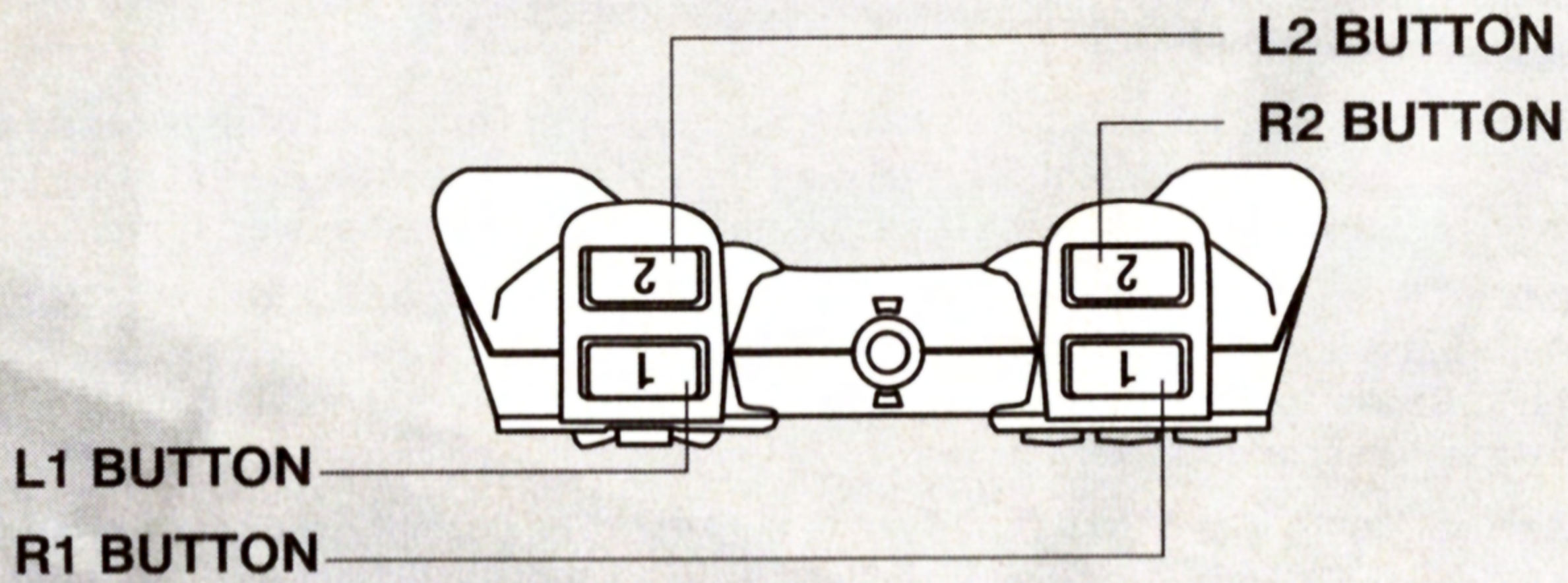

INTRODUCTION

In 1983, racing entrepreneur Carl Haas and motor sports' aficionado, Paul Newman brought their love for open-wheeled racing into competition by forming a family they call Newman/Haas Racing. Over the last 16-years, they have assembled the top names in racing, and to say that they have been successful would be an understatement.

Since Newman/Haas Racing was formed, the team has finished in the top-eight of the season point standings all but one time with 22 total entries. Newman/Haas Racing has won the PPG Cup three times and was runner-up three times. Overall, the team has finished in the top-five 11 times.

In 1997, the team debuted an American-made chassis that was built in co-operation with California-based Swift Engineering, Inc. Newman/Haas Racing engineers Peter Gibbons and Brian Liles assisted in the David Bruns-design. Along with a Ford-Cosworth powerplant and Goodyear tires, this brought an all-American package to the racecourse.

In 1998, Newman/Haas Racing is poised to build on its success. The promise of driver Christian Fittipaldi and the experience of CART's current win leader (36 victories) Michael Andretti return to steer the team to the podium.

Introducing the only game designed with the help of America's favorite racing family, Newman/Haas Racing. Welcome to the family.

STARTING THE GAME

To play NEWMAN/HAAS RACING™ on your PlayStation™ game console:

1. Set up your PlayStation™ game console in accordance with the instruction manual supplied with the system.
2. Follow your system directions to open the Disc cover and place the Disc onto the bed of the drive, ensuring the printed side faces upwards.
3. Close the Disc cover. If the unit is switched off, press the POWER button to begin play. If the unit is already on, press the RESET button.

To skip through intro screens, press the **X** button on the Controller.

WARNING! It is advised that you do not insert or remove peripherals or Memory cards while the PlayStation™ is turned on.

DEFAULT CONTROLS

- X button** – Accelerate
- button** – Brake
- button** – Reverse
- △ button** – Switch Turbo on/off (if enabled via car setup). Go back one screen when in the menu system (if you make choices and then use the △ button to go back one screen, the choices you have made will remain. They will not be cancelled.)

Left and Right Directional buttons – Steering wheel

Down Directional button – View from the front of your car (a reverse view).

Start button – Pause game and access in game options. Press again to return to game.

L1 button – Use this to move the camera view closer to the car. You can even get a cockpit view. Five views (three in 2 player mode) that are accessible using the L1 button and R1 button.

R1 button – Move the camera view away from the car.

MANUAL SHIFTING CONTROLS (DEFAULT SETTINGS)

L2 button – Downshift (only if you are using a manual transmission).

R2 button – Shift up. There are six gears that you can shift through (you will only be able to shift them yourself if you are using a manual transmission, otherwise, the computer will shift for you).

Camera Select Menu – Press and hold down the SELECT button to reveal the Camera Select Menu. A further press of an action button will reveal a different view of what's happening in the race. This feature is **ONLY** available in race mode. It is not available in the Practice or Qualifying sessions. This feature is not available on controllers which do not have a SELECT button, for example, the NeGcon.

Select button and △ button – Shows the car directly ahead of your position. You can continue to cycle through the positions, in order, by pressing the △ button repeatedly (with SELECT button remaining held down).

Select button and □ button – Toggle between the TV camera views, and the normal view setting of whatever car you've selected to see.

Select button and ○ button – Return to the view of your own car.

Select button and X button – Shows the car directly behind you in the standings. By continuing to press the X button (with SELECT button remaining pressed) you will be able to view all the cars behind your position.

NOTE: You can access all the functions that the Camera Options have to offer in the Full Replay option, available to you at the end of each race (by pressing the ○ button when appropriate). You may have a hard time viewing the competition while you are trying to win the race. Wait until the race is over to look at everyone else.

THE OPTION WHEEL (MAIN OPTION SCREEN)



Once the game is loaded, press the **X** button to take you to the **OPTION WHEEL SCREEN** where you can choose from a variety of options in preparation for the impending races.

Use the Left and Right Directional buttons on your Controller to cycle through the options. Press the **X** button on your Controller to make your choice. To go back one screen anywhere within the options sub menus, simply press the **△** button on your Controller. If you make choices and then use the **△** button to go back one screen, the choices you have made will remain. They will not be cancelled.

If you do not select any option, the game will default into a TV camera racing demo. To return to the **OPTION WHEEL SCREEN**, press any button on your Controller.

GO – Press the **X** button on your Controller to implement your option choices and move to the beginning of the type of race that you have selected.

NUMBER OF PLAYERS – Switch between one or two players by pressing the Up and Down Directional buttons on your Controller. To select a two player race, you must already have a second Controller inserted correctly into Controller port 2.



If you don't already have a Controller inserted into Controller port 2, turn off the PlayStation™ console, insert the second Controller into Controller port 2, and turn the PlayStation™ console back on. Return to the **OPTION WHEEL SCREEN** and re-select the two player mode.

***WARNING!** Do not insert or remove any peripherals while the PlayStation™ is turned on.*

HISTORY – Have an in-depth look at all the backgrounds of the drivers present in the game. You can also see the histories of the available tracks. All drivers, including Michael Andretti and Christian Fittipaldi, are profiled as are the prestigious team achievements that make up the lore of Newman/Haas Racing. There are also extensive biographies available on all the subjects and tracks. You can research the achievements of the fourteen other drivers that make up this “fight for the finish” crowd.

Cycle through all the entries of the specific category that you are currently in by using the Left and Right Directional buttons on your Controller. Use the Up and Down Directional buttons on your Controller to view the full crop of available historical background data.

GAME TYPE – Use the Up and Down Directional buttons on your Controller to choose between Championship, Single Race, and Challenge modes. These are outlined in more detail, later in the manual.

TRACK SELECTION – Use the Left and Right Directional buttons on your Controller to cycle through the available selections of racetracks. There is a description of all the tracks and an overlay of specific areas of note can be displayed by pressing the  button on your Controller. Press the  button a second time to take off the overlay. The track selection option is for use in the Single Race selection only.

LEVEL – There are four Skill levels to choose from. Use the Up and Down Directional buttons on your Controller to cycle between Amateur, Rookie, Pro, and SuperStar.

CAR SETUP – Use the Directional buttons on your Controller to select the desired Car Setup option. Press the  button to open the option for change. Use the Directional buttons again to toggle between the selection available.

Transmission – Choose between manual or automatic transmission (gears).

Fuel – With this option turned on your fuel will run down through the course of a race. Turn it off if you want unlimited fuel. Use the Left and Right Directional buttons to select fuel on or off.

Tire Wear – During the course of a long race, the tires heat up to high temperatures. This heat attracts dirt, dust and other debris which damage the tires. Bad driving technique such as riding rumble strips, contact with other vehicles and wheel spinning will cause them to wear down further. However, the main culprit responsible for tire degradation is overbraking. Overbraking occurs when a driver brakes too hard into a corner causing the wheels to lock. As a consequence the tire rapidly deteriorates on the locked area and may result in a 'flat spot'. This in turn can cause the wheel to become unbalanced and the vehicle may become difficult to control. So, if you're in the habit of braking hard, you may face an unscheduled pit stop for new tires which could cost valuable race time.

A good driver will strike a fine line between the need for hard braking and the tire damage that may ensue. Use the Left and Right Directional buttons to toggle on or off. Turning the Tire Wear off will prevent your tires from degrading during the race.

Turbo – Use the Left and Right Directional buttons to toggle on or off. Enabling the turbo will allow you to gain a limited amount of extra boost during the race.

Steer Assist – Turn on if you need a little help with your cornering. Turn off if you're happy to go it alone. Use the Left and Right Directional buttons to switch between Off, Low, Medium, or High.

Brake Assist – Turn on if you have not yet got to grips with your car's braking and this will slow you down if you approach a bend too rapidly. Turn off if you're confident of your cornering technique. Use the Left and Right Directional buttons to switch between Off, Low, Medium, or High.

Front Wing – Downforce is created by the wings on an indy car and acts to push the car down on the track. This results in improved grip and cornering but less speed on long straights because of the drag factor.

The Front Wing is used to create downforce on the front of the car. Increasing the front downforce allows tighter faster cornering. Decreasing it will result in higher speeds.

Use the Left and Right Directional buttons to switch between Min, Low, Med, High, Max.

Rear Wing – The Rear Wing is used to create downforce on the back of your car. Increasing the rear downforce will result in improved rear grip.

Use the Left and Right Directional buttons to switch between Min, Low, Med, High, Max.

If you reduce front and rear downforce this will increase your car's top speed on straights but will mean a decrease in cornering speed through tight corners. Increased front and rear downforce will result in reduced top speed on straights but also make for faster cornering.

Exit – Use the Left and Right Directional buttons to highlight this option. Press the **X** button to return to the OPTION WHEEL SCREEN.

RACE SETUP – Use the Directional buttons on your Controller to select the appropriate choice and press the **X** button to open up the further option selections available. Press the **X** button again when you've completed your choice.

Race Length – Use the left and right Directional buttons to select race length, these are automatically given in % (min 5%) increments of the maximum race length for the track chosen depending on the track restrictions. There may be a different number of laps available on different tracks.

Test Facility – You will be allowed to take a test drive on the world famous Firebird (East Test Track) course, located in Phoenix, Arizona. After the completion of your test run, you'll be escorted back to the OPTION WHEEL SCREEN to test your skills in the real world of high speed racing.

Pace Car – Use the Left and Right Directional buttons to toggle On or Off. Enabling the pace car option will cause the pace car to enter the track if a car becomes severely damaged and blocks the racing line.

Crash Spins – Use the Left and Right Directional buttons to toggle between Low, Med High.

Damage – Use the Left and Right Directional buttons to toggle between On or Off.

OPTIONS – Use the Directional buttons to move between the options. Press the **X** button on your Controller to confirm.

Controller – Newman/Haas Racing supports the standard Controller, Analog controller, NeGcon, InterAct and Madcatz steering wheels.

Sony Digital Controller – Use the Left and Right Directional buttons to select from four pre-set Controller configuration layouts. Use whichever setup that is most convenient for you. Press the **X** button to confirm. Remember that you are advised not to insert or remove any device once the console's power is turned on.

Calibrating an Analog Controller – When using an Analog controller make sure it is switched to Analog controller mode (LED display: RED). Newman/Haas Racing does not support the Digital controller mode (LED display: GREEN).

NOTE : When in Analog Controller mode, the left stick is used for steering instead of the Directional button. The right stick is used for acceleration and braking.

The Analog controller must be correctly inserted before the PlayStation™ game console is switched on. Make sure that the Analog controller is in Analog mode (the red light will be on). To

calibrate your Analog controller, select OPTIONS from the OPTIONS WHEEL, then select Controller from the OPTIONS MENU.

Select Analog Configuration from this menu then follow the on-screen instructions to calibrate the Analog controller. Once calibration has been successfully completed 'Calibration Complete' will be displayed on screen. Press the X button to return to the OPTIONS MENU. Press the Δ button at any time to cancel your selection and return to the Options Menu.

NOTE: The Analog controller can only be used in Controller port 1.

NeGcon Calibration – The NeGcon must be correctly inserted before the PlayStation™ game console is switched on. To calibrate the NeGcon, open up the Controller option, and you will see the option MAX TWIST highlighted. Twist the NeGcon fully until the blue bar reaches maximum. Next use the Down Directional button to highlight DEAD ZONE and center the NeGcon. Finally use the Down Directional button to highlight the Max Accel option. Press the I button. Then move to the Max Break option and press the II button. You will see the percentages change and your NeGcon will be calibrated. If the calibration has not worked an on screen message will advise you to press the X button to recalibrate the NeGcon. Highlight the EXIT option and press I to accept and return to the OPTIONS MENU. Press the B button at any time to cancel your selection and return to the OPTIONS menu.

InterAct/Madcatz Calibration– The InterAct/Madcatz controller must be correctly inserted before the PlayStation™ game console is switched on. To calibrate the InterAct/Madcatz, open up the Controller option, and you will see the option MAX TWIST highlighted. The options are then the same as that for the NegCon with the following actions.

Max Twist – Move the steering wheel fully.

Dead Zone – Center the steering wheel.

Max Accel – If using the pedals press the right pedal down. If using the buttons on the wheel, press the I button.

Max Brake – If using the pedals press the left pedal. If using the buttons on the wheel, press the II button.

Sound – Select the different volume levels exactly to your own, personal specifications.

CD Mode – Choose between: Commentary and Effects, Music and Effects, or Sound Effects only.

Commentary Frequency – Choose the frequency with which commentators will respond to events.

Effect Mode – Select the appropriate choice of either Dolby Surround Sound, Stereo, or Mono. Match the selection to your Television Instruction Book specifications.

Volume – Press the X button to highlight the Volume panels located on the right side of the screen. Move the Left and Right Directional buttons to increase or decrease your desired level of volume. The four volume sub-selections are: Master Volume, CD Volume, In Car Volume, and Effects Volume. Use the Up and Down Directional buttons to highlight each of the sub-selections.

CD Player – Use the left and right Directional buttons to highlight the Play selection, and press the X button. This will bring down the Music menu, so you can choose your background tunes. Select from the various options to start and stop your desired soundtrack.



Screen – Use the Directional buttons to center the screen to your satisfaction. Press the **X** button when you're satisfied with the view that you've selected.

Memory Card – Use this option to load previously saved games and settings. Ensure that you have a Memory card inserted into Memory card slot 1 on your PlayStation™ console. Use the Directional buttons to move the highlighting effect over the saved game of your choice. Press the **X** button to select. The game will then be loaded from the Memory card.

Note. High scores will be automatically saved when saving other options.

WARNING! Do not insert or remove any peripherals while the PlayStation™ is turned on. Make sure there are enough free blocks on your Memory card before commencing play. Newman/Haas Racing requires 3 free Memory card blocks.

High Scores – After you've selected a previously saved game on your Memory card, you'll be able to access any saved high scores from past races.

Exit – Press the **X** button to return to the OPTION WHEEL SCREEN.

DRIVER SELECTION – Choose from an awesome selection of sixteen of the world's fastest racers. Newman/Haas team-mates Christian Fittipaldi and Michael Andretti lead the distinguished list of racing participants. Cycle through the various drivers by pressing the Left or Right Directional buttons on your Controller and press the **X** button to confirm your selection. You will be able to select both Player controlled drivers if you've previously inserted a Controller into Controller port 1 and a Controller into Controller port 2 of your PlayStation™.

WARNING! Do not insert or remove any peripherals while the PlayStation™ is turned on.

THE THREE RACING TYPES (SINGLE RACE, CHAMPIONSHIP, AND CHALLENGE)

You can compete in one of three different types of events. The SINGLE RACE is an opportunity for you to choose the specific track on which you wish to compete. Before the racing begins, set your options to adjust your car's behavior, and then get acquainted with the terrain in a Practice Round (practice as long as you desire), a Qualifying Run (consisting of a maximum of twelve laps), and then compete in the Race itself.

SINGLE RACE

- X button** – Starts the Practice Round.
- button** – Skips you directly to the Qualifying Round.
- button** – Skips you directly to the Starting grid screen. Whichever selection you make on any pre-race screen, the **X** button will then be the next step to confirming your choice and allowing you to proceed on into your selection.

PRACTICE

An unlimited number of laps to get used to the currently selected circuit. Use this option to test a potential car set up and judge the best tire compound to use on the circuit.

NOTE: The Practice mode is the only time that you will be able to preset your Pit Orders. These are important in keeping your Pit Stop times to a minimum. After you've confirmed your cancellation of your Practice session, you will not be able to re-access the Pit Orders option (until the next track provides that opportunity).

Pause Menu – Press the START button on your Controller to access the main PRACTICE PAUSE MENU. On this menu the following selections are available: OPTIONS, PIT ORDERS (ONLY ACCESSIBLE DURING THE PRACTICE MODE), AND END PRACTICE. Pressing the START button again will take you directly back into the game. Pressing the Δ button will take you back only one screen at a time.

Options – This will bring up another menu to choose from, consisting of: Display Options, Sound Options, Map Options, and Abandon Race. Use the Directional buttons to highlight the option of your choice. Press the X button to open up the option choices. You can also press the Δ button to return to the previous menu option screen.

Display Options

Speed – Use the Left and Right Directional buttons to toggle between MPH and KPH.

Graphics – On-screen display can be changed between Dim, Bright, or completely Off (the display shows the MPH or KPH, gear, time, best lap, etc.) Use the Left and Right Directional buttons to toggle between the choices.

Sound Options

Engines – Use the Left and Right Directional buttons to have the roar of the engines turned up 100%, or in increments of 5, down to no engine noise at all. Silent racing? Unheard of!

Effects – Use the Left and Right Directional buttons to toggle between 0% and 100% in 5% increments.

Commentary – You can adjust the volume at which you hear the insightful commentary of Bobby Varsha and indy car champion driver, Danny Sullivan. Use the Left and Right Directional buttons to move from 100% of the volume, all the way down to no talking at all (just the sound of your engine, if it can still be heard).

Pressing the Δ button on your Controller will return you to the previous menu screen.

Map Options – The on-screen map will allow you to view what the other drivers are doing, in relation to your own current position. You can see if you are approaching a potentially hazardous area, or if there's nothing but open road ahead. It's also a good idea to frequently eye your map position in anticipation of oncoming corners.

Map – On or Off. By having the Map Off, you will have no further Map Options.

Zoom – Choose between: None, Max, Med and Min. This can provide a close-up view of your car's position on the track. This option will work only if the Map Option is turned to On.

Rotation – Choose between: None, With Car, or With Track. The track will rotate (or not) according to which option you choose.

Press the Δ button on your Controller to return to the previous menu screen.

Abandon Race –

Confirm? – Yes (press the X button to reach the after-race screen) or No (this will return you to the Pause Menu).

PIT ORDERS – Setting the preferences for your Pit Crew's adjustments can only be done while you are in the Practice Mode. You will want to take a look at your car's settings, as they relate to each individual track that you will be racing on. Bear in mind that for every setting change there will be a positive and negative payoff. There are no right or wrong decisions, and even a misguided decision will not be wasted provided you learn from it. In setting up an indy car, experimentation coupled with experience is the key to success.

Reset All – Use the Directional buttons to select this option. Press the **X** button to reset all PIT ORDER settings.

Springs – Indy car suspension has to be stiff enough to tolerate the powerful downforces created by high speed racing, yet soft enough to provide satisfactory grip. A softer suspension set up will make cornering less demanding on tires, but handling sensitivity and responsiveness will show a slight deterioration. A hard suspension set up will improve cornering and offer better handling but cause increased tire wear.

Use the Left and Right Directional buttons to toggle between Soft, Medium, and Hard.

Stagger – Allows you to alter the relative tire diameters of the rear tires of the car. Making the right hand side rear tire taller can improve performance around the high speed, left hand turn only ovals.

You can have the Stagger Off, or from 0.30" on up to 0.45" (by steps of 0.05 in between). Use the Left and Right Directional buttons to adjust the stagger setting.

Gearing – Gearing changes can be made to set the car up to accelerate quickly (at the cost of high speed), to attain high speeds (at the cost of acceleration) or a compromise between the two.

Use the Left and Right Directional buttons to choose between Speed, Normal, or Accelerating gearing.

Fuel Load – The 'Fuel Load' option changes the amount of fuel in the car's tank at the beginning of the race. More fuel means the car can stay out longer before refueling. Less fuel means the car will be lighter and will be quicker than a fully fuel laden car. The load can be altered during pitstops in the race.

Use the Left and Right Directional buttons to have your tank filled from 35 gallons (down in steps of 3.5). This option is only available if fuel has been enabled from the race setup screens.

Front Downforce – Use the Left and Right Directional buttons to choose between Minimum, Low, Medium, High, and Maximum respectively.

Rear Downforce – Choose between Minimum, Low, Medium, High, and Maximum.

Tire Pressure – Use the Left and Right Directional buttons to select 20psi, 25psi, 30psi, on up (by 5psi per step) to 50psi. Keep your tires down in pressure for better handling. High pressure tires are quicker and more hard wearing but make the car difficult to control.

Tire Compound – Compound is the rubber that slick tires are made from and it comes in hard and soft varieties. Softer compounds give better grip than hard compound but rapidly pick up dirt and are not as durable. Hard compounds provide less grip but this is compensated for by its

hard wearing nature. Racing on soft compound tires you may find that you can complete only one third of a race before going in for a tire change. In the same instance, racing on hard compounds would allow you to complete half of the race.

Use the Left and Right Directional buttons to switch between Hard or Soft compound.

Pressing the Δ button will return you to the previous menu screen.

There is also a PIT STOP OPTIONS menu available during pitting. See PIT STOPS section later in this manual.

END PRACTICE – Choose between Yes or No, to end your Practice session. Selecting Yes will forward you to the Start Up Screen, where your next step will be to Qualify for the upcoming race. If you select No, you will be returned to the previous menu screen.

QUALIFY – Qualifying is an essential part of the overall race preparation for any indy car team. Drivers have 12 laps in which to put in their best time for a single lap and this is then compared to all other driver times in the qualifying session to calculate the car's grid position. It stands to reason that the higher a driver's grid position at the start of a race, the better their chance of finishing among the points at the end.

The outcome of a qualifying session will sometimes dictate a team's tactical approach to the entire race. For example, drivers that are difficult to overtake may take advantage of a good grid position by running their cars fuel heavy. This is done in the knowledge that they will lose relatively few places at the start of the race. As the race progresses this tactic starts to pay off as the cars with lighter loads have to make more pitstops for fuel. With pitstops up to about 30 secs in total it can be seen how much time advantage can be gained by running a fuel heavy car from a high grid position. Conversely, for a car that has qualified down the order, it may be wiser to start on a light fuel load. This allows the driver to make the most of their weight advantage and move up several places. Coupled with a pit stop strategy that allows them to pit and refuel when caught in traffic, this may offer the best way of a lower placed driver getting among the points.

For indy car drivers the actual time that they decide to go on track for their qualifying session is a further tactical decision. Go out too early in the session and although the track will be empty, it will not have enough rubber on it to produce satisfactory grip. Leave it too late and they may get caught in traffic which will hinder their best lap time.

Press the \times button to start the Qualifying round, or the \circ button to skip directly to the Race. If you skip the Qualifying step, you will be automatically placed in the sixteenth starting position. Players who wish to advance up the championship table will make full use of the practice and qualifying sessions.

If you are happy with your qualifying place before the 12 laps are up, you can then press the START button, and cycle down to the End Qualifying selection. Confirm that you would like to end the session, and then press the \times button on your Controller to take you back to the Start Up Screen. Press the \times button on your Controller to begin your race.

QUALIFY PAUSE MENU – The options that are available to you in the QUALIFY PAUSE SCREEN MENU are the same as listed above in the PRACTICE PAUSE SCREEN listings. There is no option for adjusting your pre-set Pit Orders after the Practice round. The only change otherwise, is you'll be asked if you want to End Qualifying. Confirm this selection when you've successfully qualified for the Race.

START RACE – The race itself. However, if you go straight into a race your grid position will be last. Drivers who wish to progress up the Championship will use the practice and qualifying sessions extensively. You'll be able to view your standings on the pre-race screen. You'll also be able to visually confirm which track you're about to race on.

Press the **X** button to enter the Race. You'll play with the options that you've previously set in the Option Wheel Screen. The Race will end with the crossing of the finish line, or extreme damage to your car. You have to decide how you would like it to end. Press any other button on your Controller to quickly view the grid positions.

PAUSE MENU – Again, you can select from the Display, Sound, and Map options. You are also able to enact the Abandon Race option, if you need to exit the race prematurely. You still cannot change the Pit Orders after you've left the Practice round. Retire from race will take you to the Race Result Screen.

RACE RESULT SCREEN – You'll be able to take a look at how you are stacking up to the competition. You'll be presented with a choice of:

- X button** – Continue. This will bring you back to the Option Wheel Screen.
- button** – Restart the Race. This will take you back to the original Practice, Qualify, or Race Set Up Screen.
- button** – Full Replay. This will provide you with a full account of the race just finished. You can cycle through the different Camera View Options (refer to Default Control Settings for Camera Instructions) to view yourself and your competitors with a critical eye. Pressing the **X** button during the replay will speed up the action. Release the **X** button to return the replay to normal speed.

REPLAY PAUSE OPTIONS

Options – You can choose between the Display, Sound, and Map options during the Replay (when you've paused the replay by pressing START). The only option that will not be available is the Abandon Race option, as the race is over.

Pit Orders – Not accessible outside the Practice Options.

Abort Replay – Confirm Yes or No. Choosing YES will bring up the Returning to Options prompt. Choosing NO will default you one screen back, to the Pause menu options.

CHALLENGE RACING



Press the **X** button on your Controller when you've selected the Challenge option on the OPTION WHEEL SCREEN. This action will take you to the CHALLENGE SELECTION SCREEN.

Challenges range from simple tasks consisting of a four track Challenge with minimal options set, right up to the hardest of tracks combined with the most difficult of computer (and AI) variables.

Turn the Option Wheel to the GO option and press the **X** button to start your selected Challenge.

Remember that in this mode of racing you're sent immediately into a Challenge racing situation (no Practice, or Qualifying sessions). Your goal in the Challenge rounds is to finish the race as high as possible in each consecutive round to gain access to the next Challenge. The higher up the Challenge, the more diverse the options will become.

The player must begin with the simplest challenge and progress is dependent upon success in the previous challenge. (Unless a save with further progress is loaded from a Memory card.) You have to attain at least 60 points before you will be allowed to progress to the next challenge.

To save your Challenge progress simply finish a challenge race and then press the **O** button on your Controller when you are in the CHALLENGE POINTS SCREEN. This will take you back to the OPTIONS WHEEL where you can use the Left and Right Directional buttons to select OPTIONS.

Press the **X** button to confirm. You may then choose Memory card from the available options and perform an OPTIONS SAVE.

NOTE: You will not be able to access the Options Save if you do not already have a Memory card properly inserted, according to the Instruction manual, into your PlayStation™ console. Make sure you have enough free blocks on your Memory card before commencing play. NEWMAN/HAAAS RACING requires 3 free Memory card blocks.

WARNING! Do not insert or remove any peripherals while the PlayStation™ is turned on.

Use the Directional buttons to move the highlighting effect over the OPTIONS SAVE slot of your choice (1,2 or 3). Press the **X** button to select. Your OPTIONS SAVE will be saved to the next available 3 blocks on your Memory card.

Camera Options – See the Default Control Settings for instructions. This feature is available in the Challenge Mode.



CHALLENGE PAUSE MENU

Press the START button on your Controller to gain access to the CHALLENGE PAUSE MENU menu. The options available are outlined in the previous Single Race Pause Menu description. There is no Pit Orders option and you can Retire from the race by confirming the selection. This will advance you to the Race Result Screen (you can also reach this screen by successfully completing the Race)

RACE RESULT SCREEN / CHALLENGE POINTS SCREEN





Overall race results and fastest lap are available on this screen. Press the  button on your Controller to review your performance in the Full Replay (different camera angles, via the Select Camera Option, are available in the replay).

Press the  button on your Controller to review your standing in the CHALLENGE POINTS SCREEN. This will list your position, driver identity, and points total. Press the  button on your Controller to continue on to the next round, or the  button to return to the Option Wheel Screen.

Pressing the  button again will take you into the next Challenge Race. Try to gain the most points possible to remain high up in the standings.

CHAMPIONSHIP RACING

Highlight the CHAMPIONSHIP option on the Option Wheel Screen. Press the  button on your Controller when you have CHAMPIONSHIP selected. This will take you directly to the CHAMPIONSHIP SET UP MENU.

Championship Set Up Menu – Use the Directional buttons on your Controller to highlight your selection. Press the  button to confirm.

Champ Mode – Use the Directional buttons on your Controller to cycle through a choice of a Full Season (all 10 tracks, not including the Firebird Test Track), Random (where the tracks are chosen at random for you), or Custom (you can pick exactly which tracks you wish to race on, and eliminate those you don't want to race on).

Race Distance – Choose from 5% to 100% of the real Race distance.

Rounds – Select from four rounds, up through the full ten rounds and maybe more? Your Custom selection will depend on the number of tracks you make available to yourself.

Exit – Press the **X** button on your Controller to exit back to the OPTION WHEEL SCREEN. Use

the Directional buttons to rotate the Option Wheel to the GO selection and press the **X** button to reach the Championship Race Start Up Screen.

CHAMPIONSHIP RACE START UP SCREEN

NOTE: Please refer to the instructions listed in the Single Race Start Up Screen.

Championship Pause Menu – Press the START button on your Controller to pause a Championship race and bring up the CHAMPIONSHIP PAUSE MENU. The options remain consistent from the previous race types listed (refer to the Pause Menu entries in the Single Race section). Pressing the START button again will bring you directly back into the race, while the **△** button will take you back to the previous menu.

Camera Options

*NOTE: You can access all the functions that the Camera Options have to offer in the Full Replay option which is available to you at the end of each race (by pressing the **○** button when appropriate). You may have a hard time viewing the competition while trying to win the race. Wait until the race is over to look at everyone else. This option is ONLY available in race mode. It is not available in Practice or Qualifying sessions.*

RACE RESULT SCREEN / CHAMPIONSHIP POINTS SCREEN

You can note your placement in the Race, who drove the fastest lap, and the overall race results on this screen. Press the **○** button on your Controller to review your performance in the Full Replay (different camera angles, via the Select Camera Option, are available in the replay).

Press the **X** button on your Controller to review your standing in the CHAMPIONSHIP POINTS SCREEN. This will list your position, driver identity, and points total amassed so far. Press the **X** button again to continue on to the next round, or the **○** button to return to the Option Wheel Screen.

Pressing the **X** button again will take you into the next Championship Race (depending on how many you selected to race). Try to gain the most points possible to remain high up in the standings.

QUIT / CONTINUE / SAVE SCREEN

Along your way to RETURNING TO OPTIONS (you'll become used to that screen), you may encounter a blue screen with the choices of QUITTING THE CURRENT GAME, CONTINUING THE CURRENT GAME, or SAVING THE CURRENT GAME. Use the Directional buttons on your Controller to highlight your choice and press the **X** button to confirm your selection.

Quit Game – This will return you to the Option Wheel Screen.

Continue Game – This will default you back into the previous racing cycle that you've been in, allowing you to continue your race.

Save Game – NOTE: You will not be able to access the Save Game option if you do not already have a Memory card properly inserted, according to the system instructions into your PlayStation™ console. Make sure you have enough free blocks on your Memory card before commencing play. NEWMAN/HAAAS RACING requires 3 free Memory card blocks.

WARNING! Do not insert or remove any peripherals while the PlayStation™ is turned on.

Use the Directional buttons to move the highlighting effect over the GAME SAVE slot of your choice (1,2 or 3). Press the **X** button to select. Your game will be saved to the next available 3 blocks on your Memory card.

LOADING

See Memory card within the Options section of THE OPTION WHEEL for details on loading games from a Memory card.

PIT STOPS

(Menu not available in 2 Player mode)

In the race, you still have control over your fuel load, downforce settings and tire pressure at each pit stop. When you enter the pit you will be given the opportunity to give last minute instructions on what you would like done to your car when you enter the Pit Stop. You can then press the **△** button, when indicated by the drop down Pit menu, to quickly begin your touch up.

Fuel Load – Toggle selections with the Directional buttons, in gallons.

Front and Rear Downforce – Maximum, High, Medium, Low, and Minimum. Downforce helps your vehicle control, but impairs speed attempts.

Tire Pressure – Choose from 20psi up through 50psi (by 5psi intervals).

Abort Pit – Confirm either Yes or No. If you wait too long, you'll be defaulted into the Pit Stop in progress.

After your car has been completely (and quickly) overhauled, you'll re-enter the track in an automatic count cycle (three counts of a red dot signify this) and then you'll be cut loose on your own at the sight of the green dots (on the left hand side of the screen).

TWO PLAYER / SPLIT SCREEN

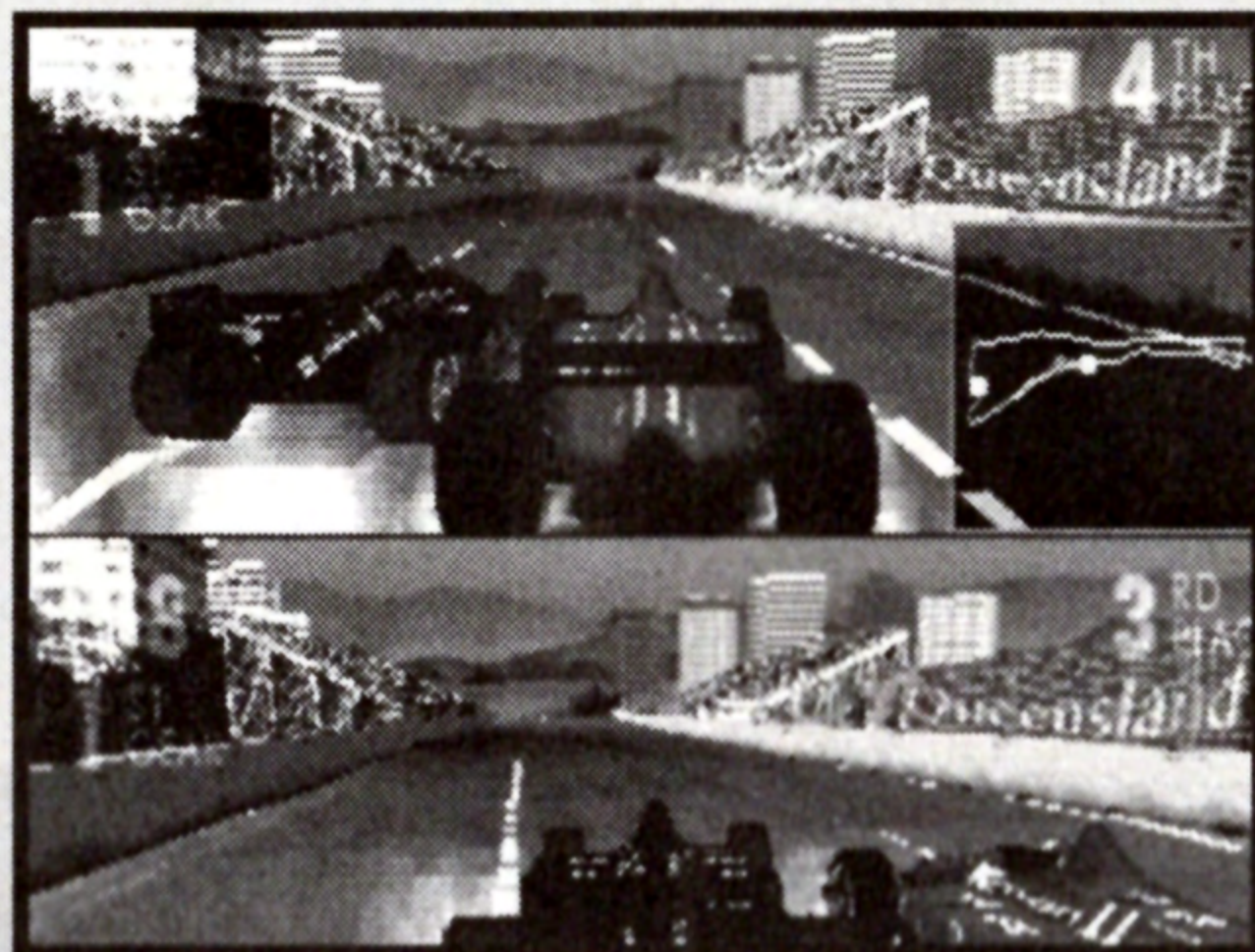

Newman/Haas Racing provides an amazing split screen (horizontal) view, so that competing drivers can race simultaneously against one another. The Championship, Challenge, and Single Race options are all available to the two player racers.

Before you switch on the power you must have a second Controller inserted into Controller port 2 of the PlayStation™ console.

WARNING! Do not insert or remove any peripherals while the PlayStation™ is turned on.

The options available to each driver must be altered by following the same procedures as in a one player game (each player must set their own options). Once a player terminates the game, the other player is also out of the race. Follow the same menu procedures that are listed for whichever two player event you and your team-mate/opponent choose.

There are only three views that are accessible to either of the two split screen racers after the green flag goes up.

RACE TIPS

Don't discount the value of tailoring your car's setup to the currently selected track (through the use of the pit orders menu in the practice session). Small changes made during practice sessions could pay dividends with crucial time saved in the actual race. Because you have unlimited time in the practice session, experiment with the pit orders and tailor your car to your particular driving style, and more importantly, to the three types of circuit: oval, street and road. Your mechanics will always set your car up to a basic setting for each type of circuit.

When a yellow flag is present, the screen will fade out to black, and competitors will restart at their current positions (if they haven't been otherwise affected by the ensuing Yellow Flag fallout). Yellow flags will only be present when the Pace Car option is enabled in the front end.

Efficient braking is very important in Newman/Haas Racing. You must learn to incorporate a style that combines both easing off the gas and braking when necessary. Remember that hard braking will result in increased tire wear. As you race around the tracks use landmarks positioned before tight turns as a guide for braking.

Aggressive overtaking has its place in any form of motor racing. However, a shrewd driver with an eye to the championship will carefully consider the risks involved. It is worth extra 1 point that you may earn by successfully forcing your way into the pack? Would it be more profitable in the long term if you were to hold your position and collect your points.

If you have the turbo active you are advised to use it sparingly. It is most profitably employed when coming out of bends and on to straights as it will help you reach your top speed quickly. It is also extremely effective for overtaking.

Amateur drivers might find racing easier from the furthest camera viewpoint (press the R1 button to 'zoom out') as it allows you to see further ahead. As your driving ability improves, you may wish to use the closer camera views as they give a more realistic and exhilarating driving perspective. For the real pros the in car view offers mirrors to avoid those meddlesome rear end shunts, or to help you block the track to your rivals! Newcomers beware there is no map in this view!

Keep a watchful eye on the fuel (if this option has been enabled), it's great to be half a lap clear of the field, but fumes are not going to get you past the flag!

Pitstops can refuel the car and give you a fresh set of tires (remember worn tires = less grip). They will also repair a damaged car, allowing you to continue to drive at top speeds.

There are areas off the track surface that can be driven over on certain circuits. Take advantage of some of these as they offer a short cut to faster qualifying times and could open up apparently closed overtaking opportunities. Be warned, however, you may lose control! In qualifying this may mean only a spin out, but in the race itself it may bring more terminal problems!

Take time in practice sessions to learn the tracks. A driver with knowledge of the track stands a better chance of success.

CREDITS

Psygnosis acknowledges the contribution of the following people, and the owners of the tracks listed below, with thanks for their assistance in the production of the game:

Christian Fittipaldi, Michael Andretti, Roberto P Moreno, Raul Boesel, Mauricio Gugelmin, Jimmy Vasser, Scott Pruett, Bryan Herta, Gil De Ferran, Patrick Carpentier, Adrian Fernandez, Mark Blundell, Andre Ribeiro, Alex Zanardi, Robby Gordon and Arie Luyendyk.

Also Danny Sullivan and Bobby Varsha.

Milwaukee, Houston, Rio, Road America, Laguna Seca, Portland, Mid Ohio, Surfer's Paradise, Toronto, Firebird and Long Beach.

Real tracks and drivers appear under licence.

SPEEDGEAR

AUTHENTIC RACEWEAR

NEWMAN/HINAS
RACING
a winning Indy car tradition

Official Team Merchandise

Team Tee

100% Cotton. Made in USA. Sizes M, L, XL.

NH8101 - Team Tee - \$20



ORDERING INFORMATION

Orders Only, Toll Free - 1-800-777-4453

(9:30 am - 9:00 pm EST M-F; 10:00 am - 4:00 pm EST Sat.)

24 Hour Fax Order Line: 1-914-381-4342

Customer Service: 1-914-381-3277

(M-F 10:00 am - 5:00 pm EST)

Visit our Web Site at <http://www.speedgear.com>

Send Orders To:
SPEEDGEAR®

Dept. ZRN98B
707 Fenimore Road
Mamaroneck, N.Y. 10543

Payment Methods

Visa/MasterCard
Discover
American Express
Money Orders
Personal Checks (2 weeks to clear)

Shipping/Handling

\$4.95 - 1 item
\$6.95 - 2 items
\$8.95 - 3 items
\$10.95 - 4 or more items
Add \$4.95 for 2nd Day Air Service

Newman Haas Official Team Merchandise



Team Logo Hat

White hat with royal blue brim. Embroidery in four places. 100% soft brushed cotton twill. Fully Adjustable. **NH8501 - Team Hat - \$20**



Michael Andretti Team Hat

Royal hat with gray brim. Embroidery in four places. 100% soft brushed cotton twill. Fully Adjustable. **MA8501 - Andretti Hat - \$20**



Christian Fittipaldi Team Hat

Black hat with gray brim. Embroidery in four places. 100% soft brushed cotton twill. Fully Adjustable. **CF8501 - Fittipaldi Hat - \$20**

SPEEDGEAR
AUTHENTIC RACEWEAR

Free catalog with hundreds of Newman Haas products including products from team drivers, Andretti and Fittipaldi plus suppliers Swift, Ford Cosworth, and Goodyear. Visit our website at Speedgear.com.

NOTES:

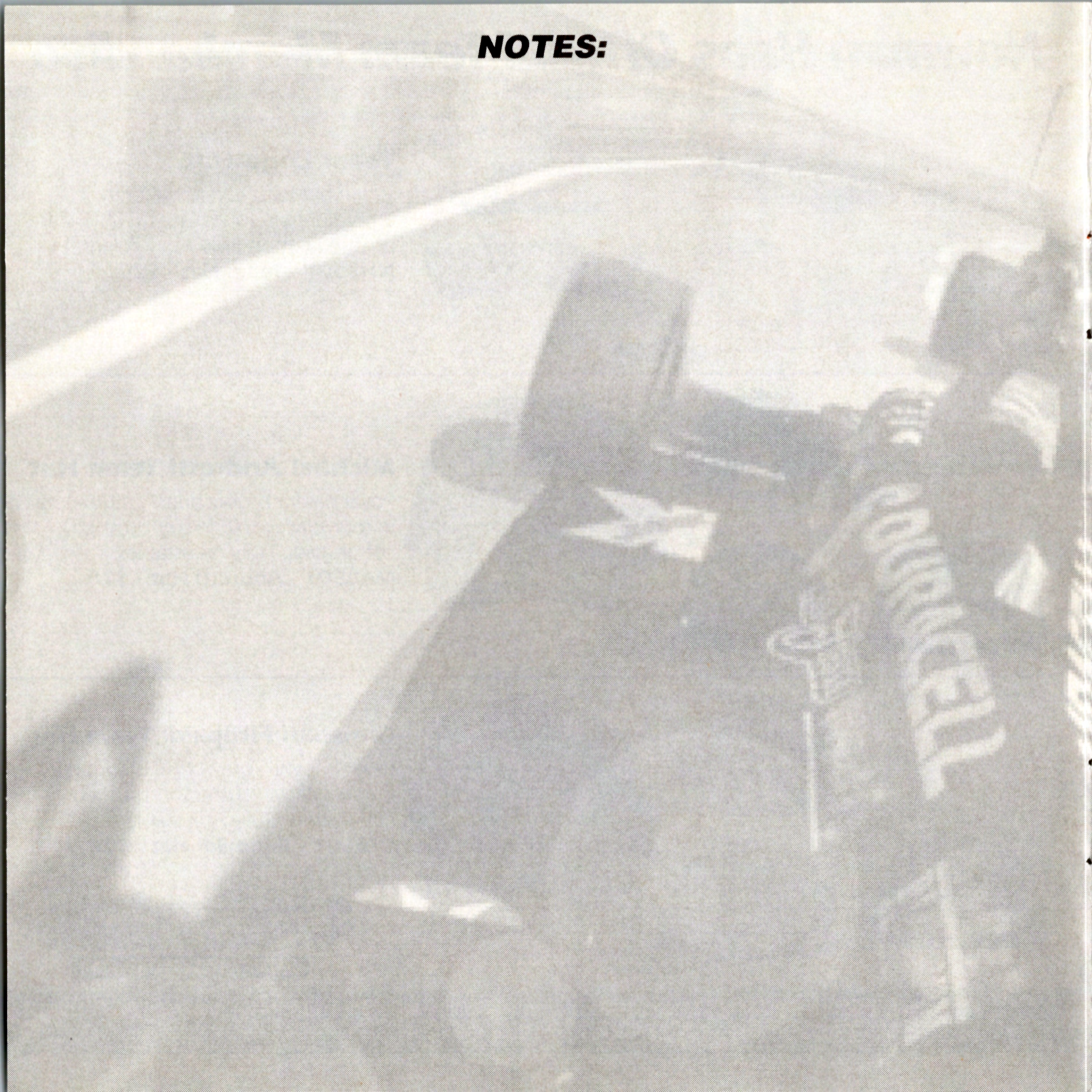



(\$0.95 per min) Live Operator Assistance (\$1.15 per min) \$4.95 for mail-out tips. Live support is available 9am-5pm M-F PST. Automated support is available 24 hours a day-7 days a week. Must be 18 years or older, or have a parent's permission to call. Prices subject to change without notice. This hint line supports games produced by Psygnosis Limited. No hints will be given on our Technical Support or Order lines. This service requires a touch-tone phone.

TECHNICAL SUPPORT

Phone: (650) 287-6583 Fax: (650) 287-6602

Technical support representatives are available at the numbers listed above M-F, 9am-5pm, PST. You may also send your questions or technical problems via e-mail to: psygtech@psygnosis.com or by writing:

Psygnosis Technical Support
989 East Hillsdale Blvd.
Foster City, CA 94404

For questions regarding PlayStation game console and its peripherals, please call:

1 (800) 345-SONY (1-800-345-7669)

Representatives are available M-F, 8AM-6PM, PST

PSYGNOSIS ONLINE

<http://www.psygnosis.com>

Our news is always hot! Visit our website and find out what's happening at Psygnosis - demos, tips and info about the games you like to play! Also, previews of new products.

PRODUCT ORDERS

Can't find Psygnosis software? Call 1-800-GET-PSYG (1-800-438-7794) for help!

LIMITED WARRANTY

Psygnosis, Ltd. warrants to the original purchaser of this Psygnosis Limited product that this Software is free from defects in material and workmanship for a period of ninety (90) days from the date of purchase, Psygnosis, Ltd. agrees for the period of ninety (90) days to either repair or replace, at its option, the Psygnosis, Ltd. product. You must provide your receipt and call 1-800-GET PSYG to receive instruction to obtain repair/replacement services. The foregoing is the sole remedy available to the original purchaser.

The licensed software and related documentation are provided as is. This warranty shall not be applicable and shall be void if the defect in the Psygnosis, Ltd. product has arisen through abuse, unreasonable use, mistreatment or neglect. THIS WARRANTY IS IN LIEU OF ALL OTHER WARRANTIES AND NO OTHER REPRESENTATIONS OR CLAIMS OF ANY NATURE SHALL BE BINDING ON OR OBLIGATE PSYGNOSIS, LTD. ANY IMPLIED WARRANTIES APPLICABLE TO THIS SOFTWARE PRODUCT, INCLUDING WARRANTIES OF MERCHANTABILITY AND FITNESS FOR A PARTICULAR PURPOSE, ARE LIMITED TO THE NINETY (90) DAY PERIOD DESCRIBED ABOVE. IN NO EVENT WILL PSYGNOSIS, LTD. BE LIABLE FOR INCIDENTAL OR CONSEQUENTIAL DAMAGES RESULTING FROM POSSESSION, USE OR MALFUNCTION OF THE PSYGNOSIS, LTD. SOFTWARE PRODUCT.

Some states do not allow limitations as to how long an implied warranty lasts and /or exclusions or limitations of consequential damages, so the above limitations and/or exclusions of liability may not apply to you. This warranty gives you specific legal rights, and you may also have other rights which vary from state to state.

FORMULA 1

Championship Edition



**IN STORES
NOW!**



Psygnosis, 989 E. Hillsdale Blvd., Foster City, CA 94404
An official product of the FIA Formula One World Championship licensed by Formula One Administration Limited. © Psygnosis Ltd. 1998. Psygnosis and the Psygnosis logo are trademarks or registered trademarks and © 1990-8 of Psygnosis Ltd. Developed by Studio 33 (UK) Ltd. in conjunction with Bizarre Creations. Newman/Haas is a trademark of Newman/Haas Racing. Real tracks and drivers appear under license. ALL RIGHTS RESERVED. Licensed by Sony Computer Entertainment America for use with the PlayStation game console. PlayStation and the PlayStation logos are trademarks of Sony Computer Entertainment Inc. The ratings icon is a trademark of the Interactive Digital Software Association. Manufactured and printed in the U.S.A. THIS SOFTWARE IS COMPATIBLE WITH PLAYSTATION GAME CONSOLES WITH THE NTSC U/C DESIGNATION. U.S. AND FOREIGN PATENTS PENDING.